

LA CROSSE®  
TECHNOLOGY

# WIRELESS RAIN STATION

WITH INDOOR/OUTDOOR TEMP + HUMIDITY



MODEL #: 724-1415BL  
DC: 032619

# TABLE OF CONTENTS

- [3. Power Up](#)
- [3. Button Functions](#)
- [4. Basic Settings](#)
- [6. Flower Icon](#)
- [7. Rainfall Readings](#)
- [7. Rain History](#)
- [9. Reset Rain](#)
- [10. Optional Backlight](#)
- [10. Optional Auto Dim Backlight](#)
- [11. Indoor & Outdoor Temperature/Humidity Readings](#)
- [11. Low Battery Indicator](#)
- [12. Search for Sensors](#)
- [12. We're Here to Help](#)
- [12. Join the Conversation](#)
- [13. Specifications](#)
- [13. Warranty Info](#)
- [13. Care + Maintenance](#)
- [13. FCC Statement](#)

# POWER UP

1. Insert 2-AA batteries into your TH Sensor.
2. Insert 2-AA batteries into your Rain Sensor.
3. Insert 2-AA batteries into your Rain Station Display.
4. Configure Basic Settings.

**Note:** Use the USB Power Cord for constant backlight.

Thermo-Hygro (TH) Sensor  
TX141TH-Bv3

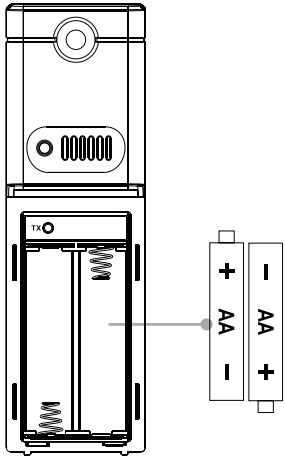

Rain Sensor  
TX14RBL

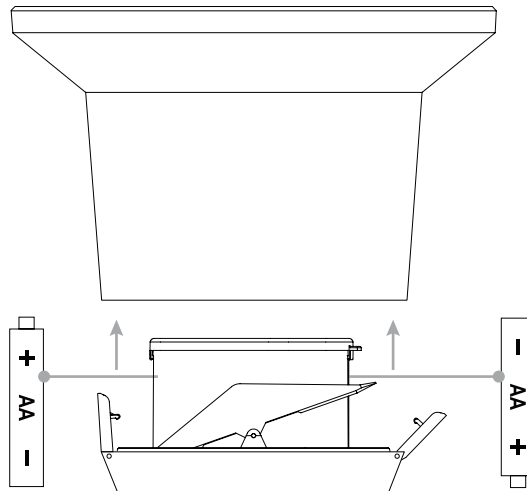

Rain Station  
725-1415BL  
(Back)

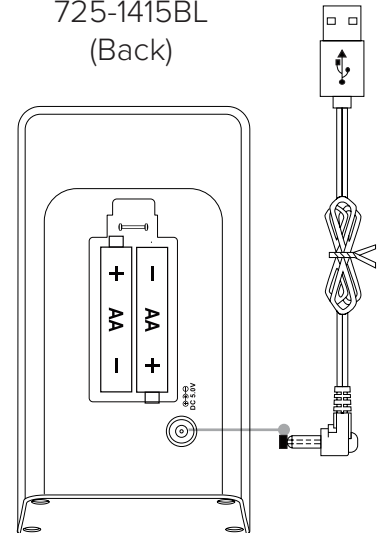

# BUTTON FUNCTIONS



BUTTON	FUNCTION
+	Press to toggle between Indoor and Outdoor Temperature/Humidity readings. Hold to search for the TH and Rain Sensors. When viewing Rain History (Month), press to view your past 12 months of rain data.
-	When viewing Rain History, hold to reset individual History Records.
HISTORY	Press to view Rain History (1 Hr, 24 Hr, 7 Days, Month, Year, Total) Hold to set Rain Alert.
SET	Hold to enter the Settings Menu. Press to confirm settings in the Settings Menu.
LIGHT	Battery Power Only: Press for a 10 second backlight. When using the USB Power Cord: Press to adjust backlight brightness. Hold to select Auto Dim settings.
+ & LIGHT	Hold to factory reset Rain Station.

For better programming instructions, please note these terms for button use:

- **Press:** Press the designated button.
  - **Hold:** Hold the button for 3 seconds (or 5 seconds if resetting) then release the button.
- Note:** For any function other than Factory Reset, be sure to press or hold only **one button at a time**.

**Note:** If no buttons are pressed for 10 seconds your station will return to normal rain display.

## BASIC SETTINGS

1. Hold the SET button to enter the Settings Menu.
2. Use the + or – button to adjust, and SET to confirm.
3. Press the LIGHT button at any time to exit.

### Settings Menu Order:

- Language (English, Español, Français)
- Beep ON/OFF
- 12/24 Hour Format
- Hour
- Minutes
- Year
- Month
- Date
- Temperature: Fahrenheit/Celsius
- Rainfall: Inches/Millimeters
- Rainfall: AVERAGE/HIGH/LOW

**Note:** This final setting is only used to define changes to the Flower Icon 🌸 See chart for details.

**Note:** Weekday will set automatically when Year, Month and Date are set.

### LANGUAGE

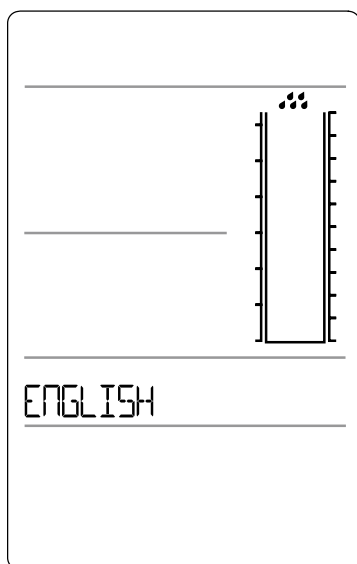

### BEEP ON/OFF

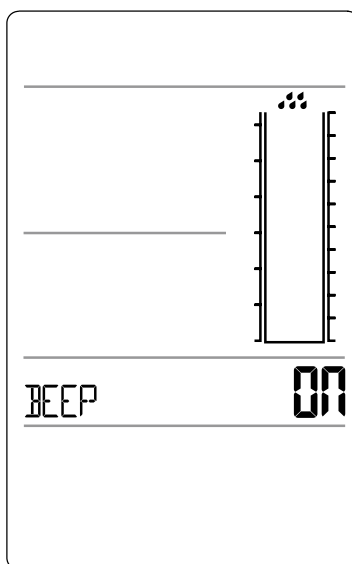

### 12/24 HOUR FORMAT

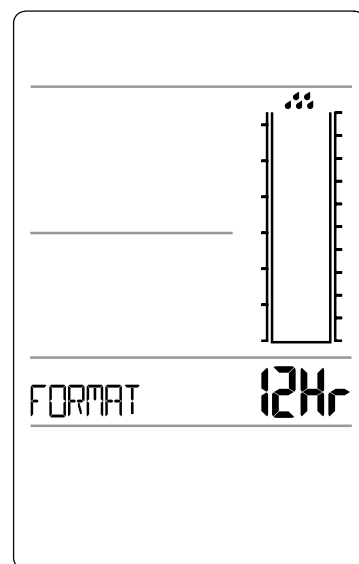

HOUR

12 PM

HOUR

MINUTES

34

MINUTES

YEAR

20 19

YEAR

MONTH

JANUARY

DATE

/23

DATE

FAHRENHEIT/CELSIUS

TEMP OF

INCHES/MILLIMETERS

RAINFALL INCHES

AVERAGE/HIGH/LOW

RAINFALL AVERAGE





# FLOWER ICON

In most regions of the country, the AVERAGE Rainfall Setting will work just fine. However, if you're in a region that has higher or lower than average rainfall per year, make sure to select the appropriate setting in the Settings Menu. This will adjust how your Flower Icon animates to changing rain conditions.

The Flower Icon will update at 12AM each day, or at the start of any rain event. See chart for details.

## FLOWER ICON CHART

## Default

ICON	Low Regional Rainfall	Average Regional Rainfall	High Regional Rainfall
	7+ days of Rain	4+ days of Rain	4+ days of Rain
	0-24 Days Without Rain & 0-6 Days of Rain	0-9 Days Without Rain & 0-3 Days of Rain	0-6 Days Without Rain & 0-3 Days of Rain
	25-49 Days Without Rain	10-14 Days Without Rain	7-10 Days Without Rain
	50-99 Days Without Rain	15-19 Days Without Rain	11-17 Days Without Rain
	100+ Days Without Rain	20+ Days Without Rain	17+ Days Without Rain

# RAINFALL READINGS

Your Rain Station provides a 24 hour reading as the default setting. This allows you to quickly see the rainfall total for the past day. However when new rain occurs, your station will temporarily switch to a Current Rain view so you can keep up on the latest storm total. When it has stopped raining for 15 minutes, your station defaults back to showing the past 24 hours of rainfall.

**24-Hour Rain:** A running total of the rainfall accumulated in the past 24 hours. This is the station's default reading.

**Current Rain:** At the start of a new rain event, the CURRENT Rainfall Reading will automatically appear. After 15 minutes of no additional rain, the station will return to the 24-Hour Rain Display.

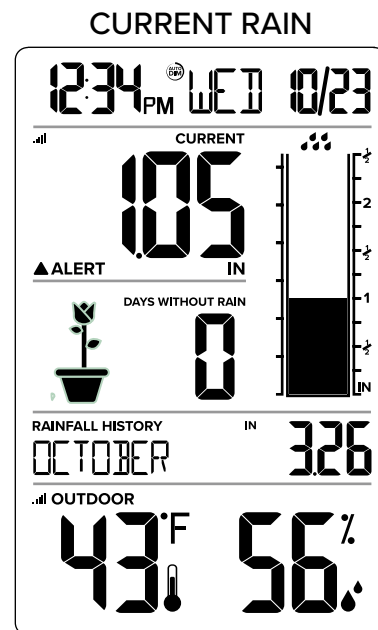
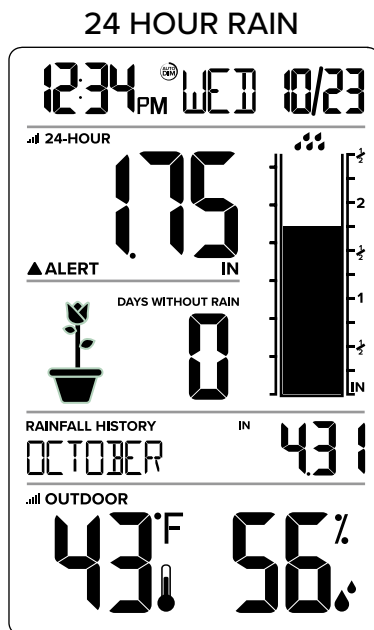

## RAIN HISTORY

Below the Flower Icon is the Rainfall History. You can select what history time frame you wish to display here. Simply press and release the HISTORY button to toggle through: • 1 HOUR • 24 HOURS • 7 DAYS • MONTH • YEAR • TOTAL.

**1 HOUR:** Last one hour rain fall (12 consecutive 5 minutes rainfall accumulated total). Example: current time is 6:49, 1HR rain is accumulated total between 5:50 to 6:49. Updates every 5 minutes.

**24 HOUR:** Based on past 24 hours accumulated rain total. At each full hour, 1 hour rainfall is recorded. This is a running total. **Note:** this is the default setting for the readings at the top of the station. 24 HOUR rain is also an option in the Rain History section.

**7 DAYS:** Accumulated last 7 consecutive 24HR rainfall readings. Updates at midnight each day. This reading is not subject to the calendar. Be sure time is set.

**MONTH:** Current Month. Ex: January 1-January 31. At the first month calendar day 0:00, month rain is reset to 0. Accumulated rain from 1st of (month) to current day (month). Current month will show in date area.

**Note:** You can toggle through the past 11 months of rainfall history when you are in Month view. Press the HISTORY button to view MONTH Rainfall. Press and release the PLUS (+) button to toggle through the past monthly history readings.

**YEAR:** Current year January 1-December 31 total. Example: current is date is Nov. 10, 2018. Year rain is Jan 1, 2018 –Oct 31 2018 month totals, plus the current month (Nov 1-10) rain.

**TOTAL:** Total rainfall since powered on or reset.

**Note:** As time passes without rain, the 1 hour, 24 hour, and 7 day rain totals will count down to zero.

**Note:** The Rain Cylinder Graph will not change with Rainfall History. It only changes with 24 hour and Current Rain.

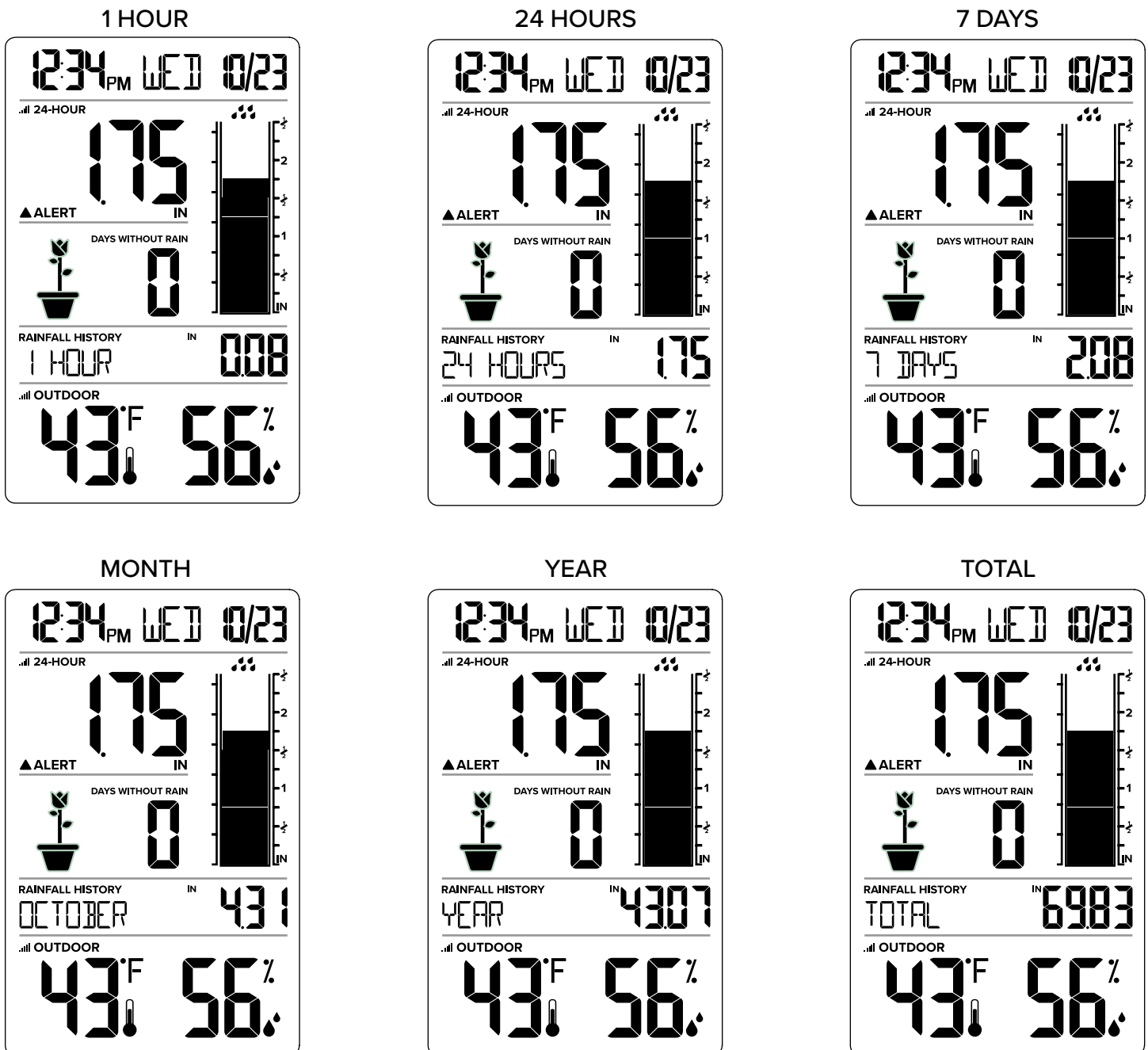



# RESET RAIN HISTORY

When viewing Rain History, Hold the (-) MINUS button to reset the History readings individually. The reading will show dashes briefly then show zero.

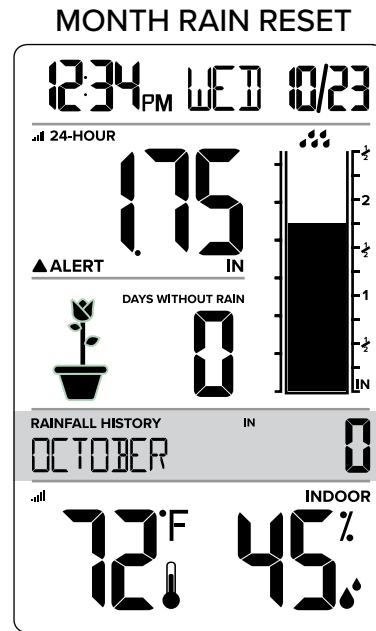
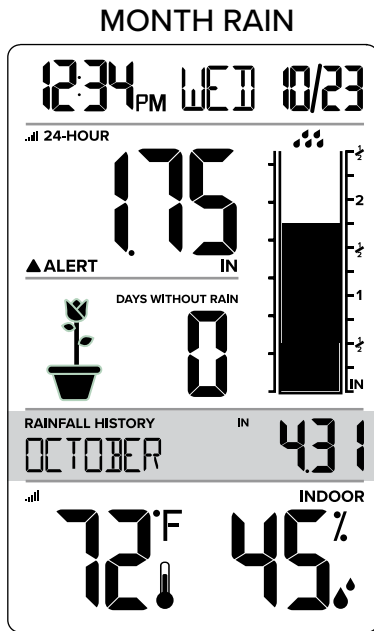

# 24 HOUR RAIN ALERT

1. Hold the HISTORY button 2 seconds to enter settings mode.
2. Press the + or – button to Arm or Disarm the Rain Alert. Alert icon ▲ALERT will show when armed.
3. Press the HISTORY button to move to Alert value. Value will flash.
4. Press the + or - button to adjust the flashing value. Hold to adjust quickly.
5. Press the HISTORY button to confirm and exit.

**ALERT OFF**

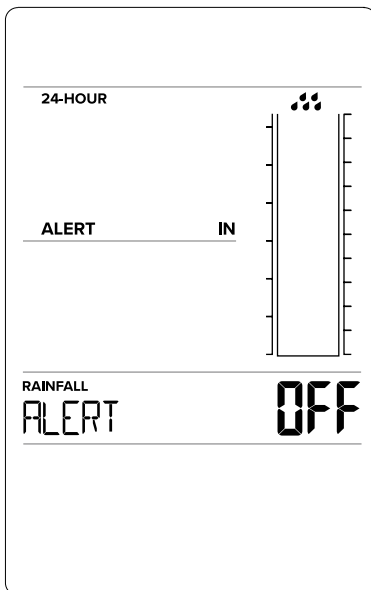

**ALERT ON 0.50 in**

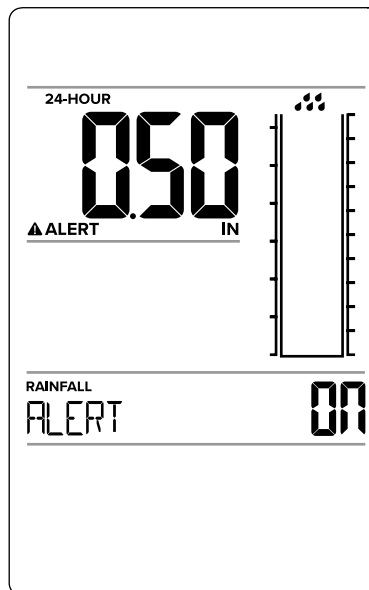

**ALERT ON 0.25 in**

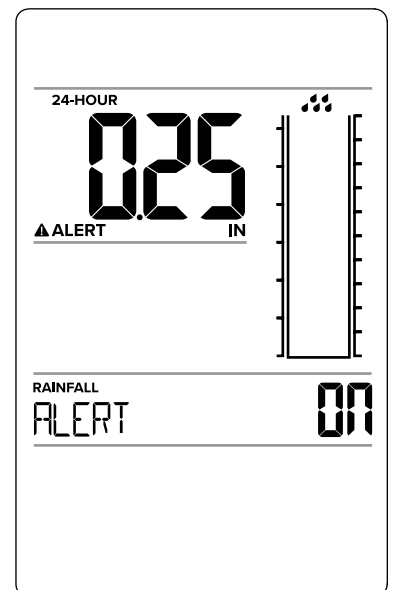

### Active Rain Alert:

- When the armed alert value is reached, your station will beep 5 times each minute, until out of alert range. The flashing alert icon will indicate alert.
- Press any button to stop the temp alert sound.
- The alert icon will show while value is in alert range.

### Disarm Alert:

1. Hold the HISTORY button 2 seconds to enter settings mode.
2. Press the + or – button to Disarm the Rain Alert.

## OPTIONAL BACKLIGHT

### Battery Operation:

- Press the LIGHT button to activate the backlight for 10 seconds.

### USB Power Cord (Required):

- You can have a constant backlight when using the USB Power Cord.
- Press and release the LIGHT button to adjust the backlight 5 levels (OFF | 1.5% | 20% | 50% | 100%. ).
- BACKLIGHT and intensity level will show briefly.

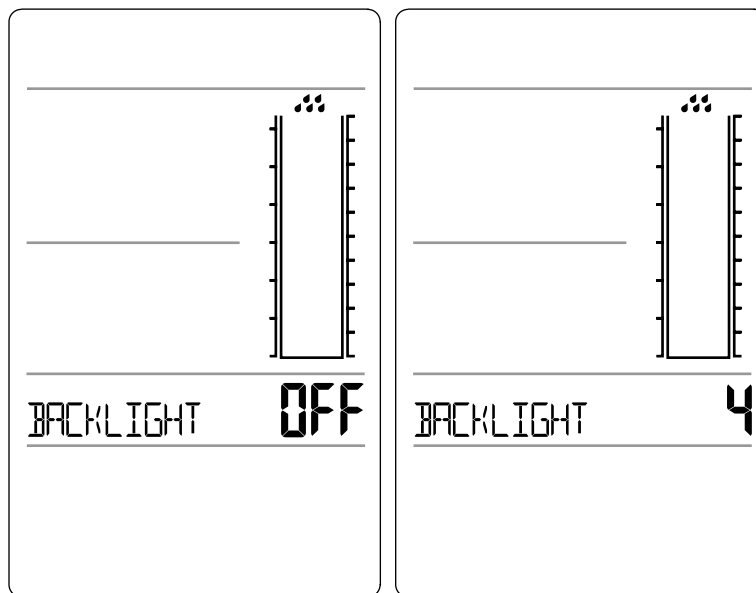

## OPTIONAL AUTO DIM BACKLIGHT

### USB Power Cord (Required):

- Program your backlight to automatically dim to 1.5% at a set hour, and return to 100% at a set hour.

### Set Auto Dim Hour:

1. Hold the LIGHT button 2 seconds to enter dimmer set mode. AUTO DIM OFF will show.
2. Press the + or – buttons to turn dimmer (ON). AUTO DIM ON will show.
3. Press the LIGHT button to select start time (Hour) for dimmer. START TIME and the hour will flash.
4. Press the + or – buttons to change the hour for the dimmer to be low light level.
5. Press the LIGHT button to select start time for dimmer to be on High light level. STOP TIME and the hour will flash.
6. Press the + or – buttons to change the hour for the dimmer to be high light level.
7. Press the LIGHT button to confirm and exit.

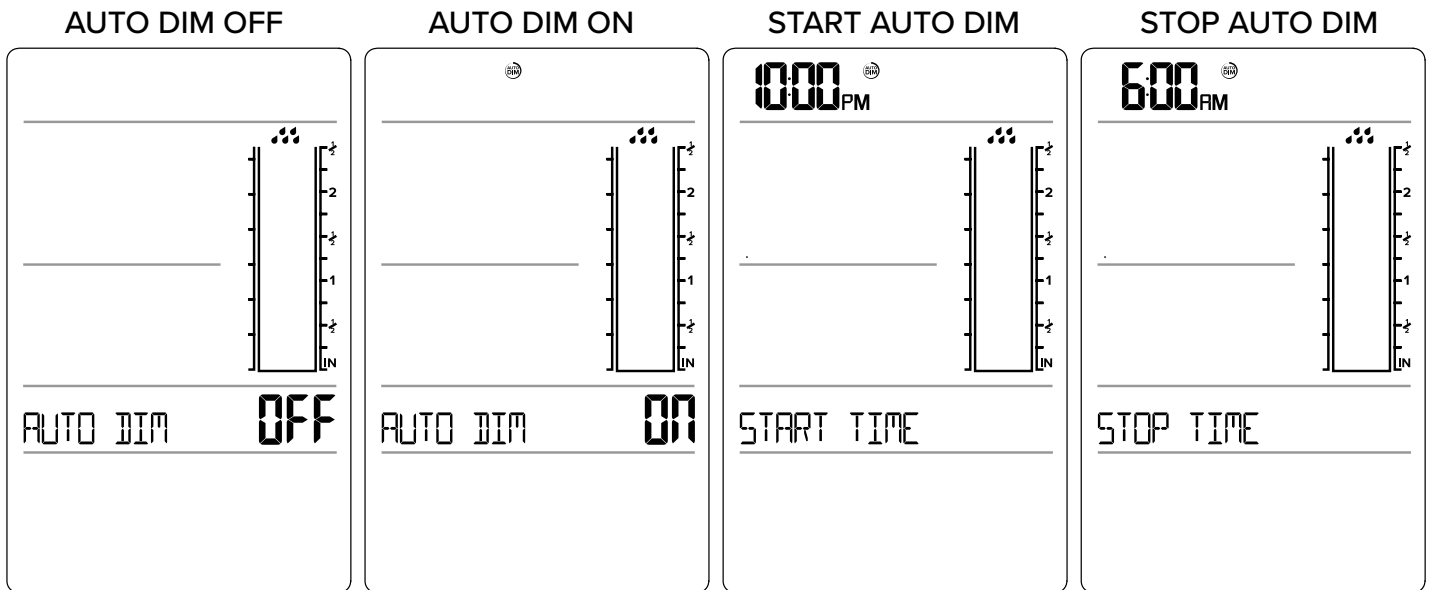

The AUTO DIM icon  will show constantly when Auto Dim is set.

## INDOOR & OUTDOOR TEMPERATURE / HUMIDITY READINGS

- Your station has both Outdoor Temperature/Humidity and Indoor Temperature/Humidity.
- Press the PLUS (+) button to view Indoor or Outdoor readings.
- Your station will stay on your last selection.

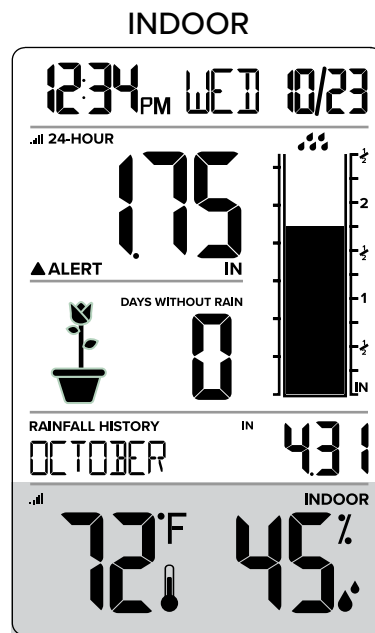
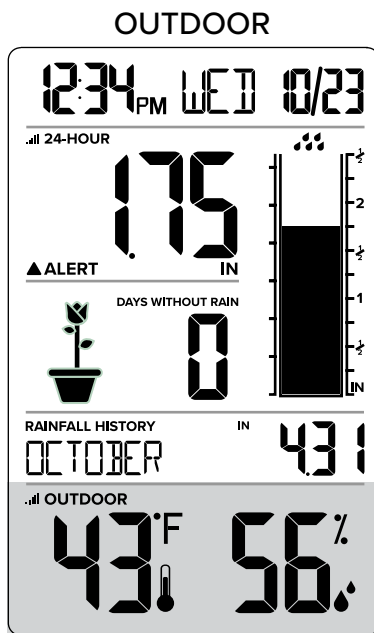

## LOW BATTERY INDICATORS

- When the Battery Indicator appears near the Time, replace batteries in the Station.
- When the Battery Indicator appears near the Rain reading, replace batteries in the Rain Sensor.
- When the Battery Indicator appears near the Outdoor Temperature, replace batteries in the Outdoor Sensor.

# SEARCH FOR SENSORS

- If either sensor loses connection, the station will show **NO** after 30 minutes of no reception.
- The station will automatically search for 3 minutes every hour to try and reestablish the sensor connection.
- To manually search for both sensors, hold the PLUS (+) button until the Reception Icon  begins to flash. Dashes will show while searching.

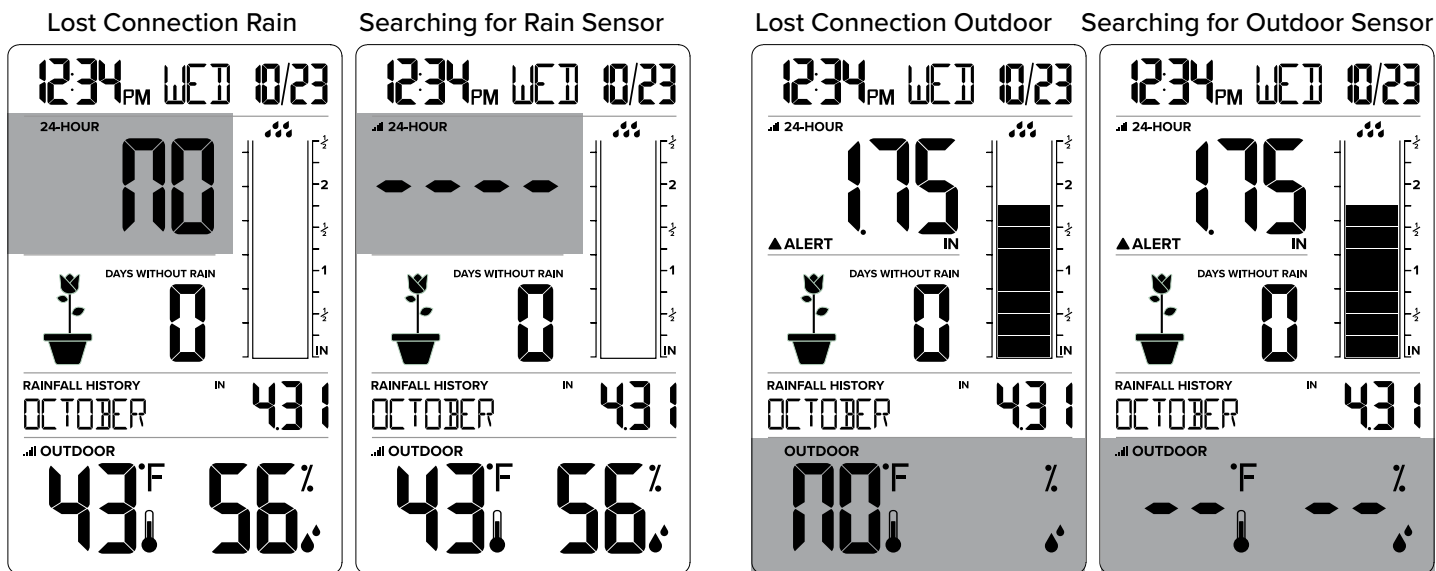

## WE'RE HERE TO HELP!

If you require additional support, call our friendly customer support representatives based out of our office in La Crosse, Wisconsin.

Phone: 1.608.782.1610

Or fill out our online support request form here: [bit.ly/contact\\_techsupport](https://bit.ly/contact_techsupport)

Our knowledgeable customer support team is available:  
Monday-Friday, 8AM–6PM CST.

## JOIN THE CONVERSATION

Ask questions, watch detailed setup videos, and provide feedback on our social media outlets!

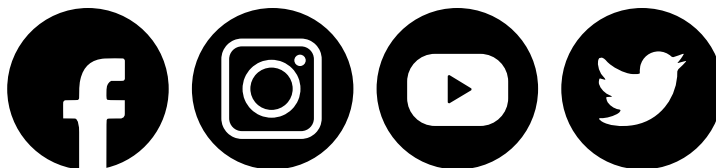

# SPECIFICATIONS

## Rain Station (724-1415BL)

**Indoor Temperature Range:** 32°F to 122°F (0°C to 50°C)

**Indoor Humidity Range:** 10%RH to 99%RH

**Primary Power:** 2 “AA” Alkaline Batteries (sold separately)

USB Power Cord Included (USB180-P11W) for use with external adapter

**Dimensions:** 3.24”L x 2.16”W 5.98”H (8.23 cm L x 5.48 cm W x 15.19 cm H)

## TH Sensor (TX141TH-Bv3)

**Outdoor Temperature Range:** -40°F to 140°F (-40°C to 60°C)

**Outdoor Humidity Range:** 10%RH to 99%RH

**Wireless Range:** Over 330 Foot (100 meter)

**Requires:** 2 “AA” Alkaline Batteries (sold separately)

**Dimensions:** 1.57”L x 0.82”W 4.94”H (3.98 cm L x 2.08 cm W x 12.98 cm H)

## Rain Sensor (TX14RBL)

**Rain Range:** 0 to 393.6 inches (0 to 999.9 cm)

**Wireless Range:** Over 330 Foot (100 meter)

**Requires:** 2 “AA” Alkaline Batteries (sold separately)

**Dimensions:** 7.14”L x 3.43”W 4.94”H (18.13 cm L x 8.72 cm W x 12.54 cm H)

## WARRANTY INFO

La Crosse Technology, Ltd. provides a **1-year limited time warranty** (from date of purchase) on this product relating to manufacturing defects in materials & workmanship.

La Crosse Technology, Ltd

2830 S. 26th St.

La Crosse, WI 54601

**For Full Warranty Details, Visit:** [www.lacrossetechnology.com/support](http://www.lacrossetechnology.com/support)

## CARE + MAINTENANCE

- Do not mix old and new batteries.
- Do not mix Alkaline, Lithium, standard, or rechargeable batteries.
- Always purchase the correct size and grade of battery most suitable for intended use.
- Clean the battery contacts and also those of the device prior to battery installation.
- Ensure the batteries have with correct polarity (+ / -).
- Remove batteries from equipment that will not to be used for an extended period.
- Promptly remove expired batteries.

## FCC STATEMENT

This equipment has been tested and found to comply with the limits for a Class B digital device, pursuant to part 15 of the FCC Rules. These limits are designed to provide reasonable protection against harmful interference in a residential installation. This equipment generates, uses and can radiate radio frequency energy and, if not installed and used in accordance with the instructions, may cause harmful interference to radio communications. However, there is no guarantee that interference will not occur in a particular installation. If this equipment does cause harmful interference to radio or television reception, which can be determined by turning the equipment off and on, the user is encouraged to try to correct the interference by one or more of the following measures:

- Reorient or relocate the receiving antenna.
- Connect the equipment into an outlet on a circuit different from that to which the receiver is connected.
- Increase separation between equipment & receiver.
- Consult the dealer or an experienced radio/TV technician for help.

This device must not be co-located or operating in conjunction with any other antenna or transmitter.

Operation is subject to the following two conditions:

- (1) This device may not cause harmful interference, and
- (2) This device must accept any interference received, including interference that may cause undesired operation.

## CAUTION!

The manufacturer is not responsible for any radio or TV interference caused by unauthorized changes or modifications to this equipment. Such changes or modifications could void the user authority to operate the equipment.

All rights reserved. This manual may not be reproduced in any form, even in part, or duplicated or processed using electronic, mechanical or chemical process without the written permission of the publisher.

This booklet may contain errors or misprints. The information it contains is regularly checked and corrections are included in subsequent editions. We disclaim any responsibility for any technical error or printing error, or their consequences. All trademarks and patents are recognized.



**WARNING:** This product can expose you to chemicals including styrene, which is known to the State of California to cause cancer. For more information go to: [www.P65Warnings.ca.gov](http://www.P65Warnings.ca.gov)